

Composite dry sliding bushings, metric dimensions

Principal dimensions			Basic load ratings		Mass	Designation
d	D	B	dynamic C	static C0	kg	-
mm			kN			
70	75	40	220	680	0,17	PCM 707540 E

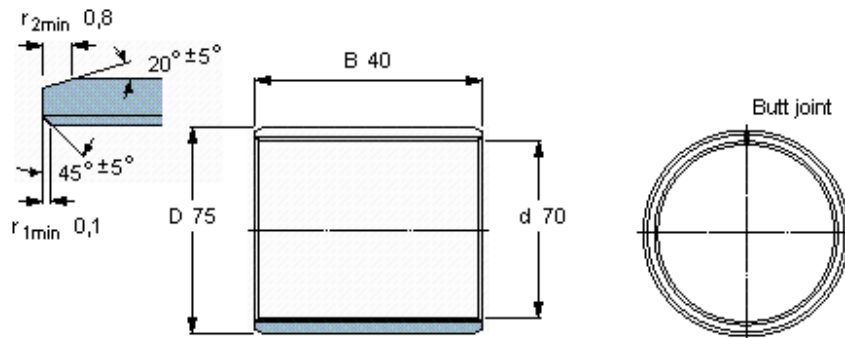

Specific load factor	K 80
Material constant	K_M 480